

## TECHNICAL DATA SHEET

### AMBER OAK | UV LACQUER

#### PRODUCT DETAIL

<b>Collection:</b>	TREND
<b>Wood species:</b>	European Oak
<b>Finish:</b>	UV Lacquer
<b>Surface:</b>	Lightly Brushed, 4V
<b>Profile:</b>	Tongue & Groove
<b>Wood class:</b>	Natur   Rustic
<b>Construction:</b>	Solid   Engineered

#### AMBER OAK | UV LACQUER, NATUR CLASS



#### AMBER OAK | UV LACQUER, RUSTIC CLASS



#### SOLID CONSTRUCTION

PATTERN	DIMENSION [mm]
<b>FLOORBOARD</b> 	
90 mm — mix of lengths from 300 to 1200 mm —	15x90x300-1200*
130 mm — mix of lengths from 300 to 1200 mm —	15x130x300-1200*
150 mm — mix of lengths from 300 to 1200 mm —	15x150x300-1200*
* The length of the boards in the given range or longer.	

#### ENGINEERED CONSTRUCTION

PATTERN	DIMENSION [mm]
<b>FLOORBOARD</b> 	
90 mm — mix of lengths from 600 to 1200 mm —	15/4x90x600-1200*
135 mm — mix of lengths from 800 to 1800 mm —	15/4x135x800-1200*
155 mm — mix of lengths from 800 to 1800 mm —	15/4x155x800-1800*
180 mm — mix of lengths from 1800 to 2400 mm —	15/4x180x1800-2400*
220 mm — mix of lengths from 1800 to 2400 mm —	15/4x220x1800-2400*
* The length of the boards in the given range or longer.	

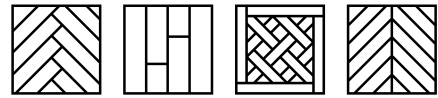

## TECHNICAL DATA SHEET

### SOLID CONSTRUCTION

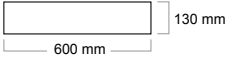
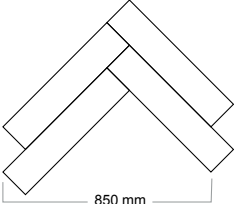
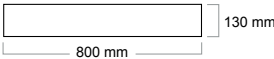
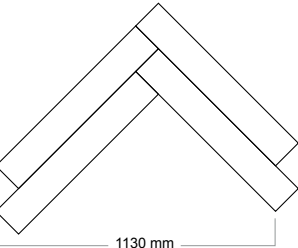
PATTERN	DIMENSION [mm]
<b>HERRINGBONE</b>   	15x130x600
 	15x130x800

### ENGINEERED CONSTRUCTION

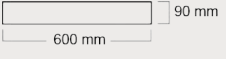
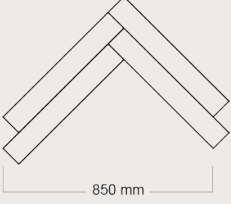
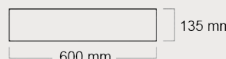
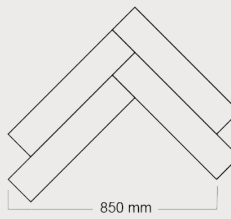
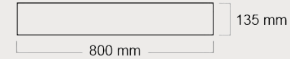
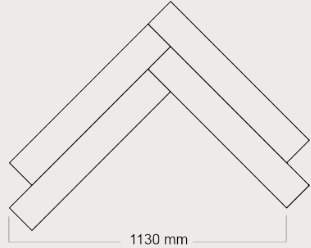
PATTERN	DIMENSION [mm]
<b>HERRINGBONE</b>   	15/4x90x600
 	15/4x135x600
 	15/4x135x800



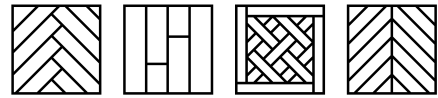

## TECHNICAL DATA SHEET

### SOLID CONSTRUCTION

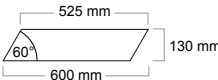
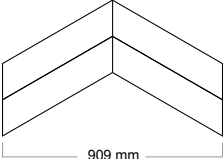
PATTERN	DIMENSION [mm]
<p><b>CHEVRON 60</b></p>   	15x130x600

### ENGINEERED CONSTRUCTION

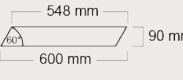
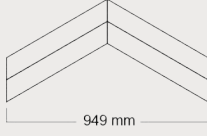
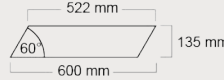
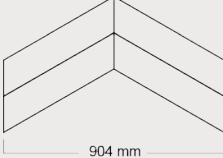
PATTERN	DIMENSION [mm]
<p><b>CHEVRON 60</b></p>   	15/4x90x600
 	15/4x135x600

\* Other floor sizes are available periodically, during promotional campaigns or on individual request.

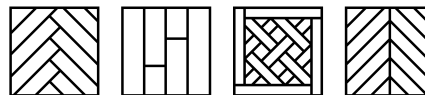

## TECHNICAL DATA SHEET

### SOLID CONSTRUCTION

#### CERTIFICATION

<b>CE</b>	The CE Declaration of Performance
<b>Symbols on the package</b>	CE, FSC

#### INSTALLATION

<b>Installation method</b>	Glue down to the substrate
<b>Underfloor Heating</b>	No

### TECHNICAL DATA

<b>Harmonized technical specification</b>	PN-EN 14342
<b>Detailed subordinate standard</b>	PN-EN 13226
<b>Permissible deviations in the thickness of the top layer</b>	N/A
<b>Permissible width deviation</b>	+/- 0,2 mm
<b>Permissible deviation of squareness and other account deviations</b>	0.2% of the element width
<b>Thickness tolerance</b>	+/- 0,2 mm
<b>Transverse curvature</b>	≤0,7% of the element width
<b>Longitudinal curvature of the sides</b>	≤0,5% of the element length
<b>Top layer moisture when leaving the factory</b>	from 7% to 11%
<b>Thermal conductivity</b>	0,17 W/mk
<b>Reaction on fire</b>	Cfl-s1 according to EN-PN 14342. According to the standard
<b>Thermal resistance</b>	Thickness 15 mm - 0,088 m <sup>2</sup> K/W

### ENGINEERED CONSTRUCTION

#### CERTIFICATION

<b>CE</b>	The CE Declaration of Performance
<b>Symbols on the package</b>	CE, FSC

#### INSTALLATION

<b>Installation method</b>	Glue down to the substrate
----------------------------	----------------------------

#### Underfloor Heating

The engineered floor is suitable for installation in the underfloor heating system. It is forbidden to install the floor on the subfloor which is only partially equipped with underfloor heating. The maximum temperature of the floor surface shouldn't exceed 27°C. The substrate with the heating system must be properly heated, and the process must be documented in a heating protocol. The underfloor heating system must be equipped with a temperature limiter.

### TECHNICAL DATA

<b>Harmonized technical specification</b>	PN-EN 14342
<b>Detailed subordinate standard</b>	PN-EN 13489
<b>Permissible deviations in the thickness of the top layer</b>	up to 20% of the nominal thickness of the surface layer (depending on the surface method: grinding, brushing, aging, grooving, saw marks), the thickness of the top layer 4 mm
<b>Permissible width deviation</b>	+/- 0,2 mm
<b>Permissible deviation of squareness and other account deviations</b>	0.2% of the element width
<b>Thickness tolerance</b>	+/- 0,2 mm
<b>Transverse curvature</b>	≤0,2% of the element width
<b>Longitudinal curvature of the sides</b>	≤0,1% of the element length
<b>Top layer moisture when leaving the factory</b>	from 5% to 9%
<b>Thermal conductivity</b>	0,17 W/mK – engineered construction (plywood + oak) 0,13 W/mK – three-layer construction (softwood + oak)
<b>Reaction on fire</b>	Dfl-s1 zgodnie z EN-PN 14342
<b>Thermal resistance</b>	0,088 m <sup>2</sup> K/W – engineered construction (plywood + oak) 0,115 m <sup>2</sup> K/W – three-layer construction (softwood + oak)



## TECHNICAL DATA SHEET

---

### CLASSIFICATION FOR QUERCUS (OAK)

**NATUR CLASS** (marked in the relevant standards with the symbol  $\Delta$ ) – natural wood colour and structure; any arrangement of growth rings, slight natural discolouration; max. diameter of stick knots – engineered floor 8 mm, solid floor 10 mm allowed. Occasional surface fractures are acceptable up to 15 mm in solid floorboards, up to 20 mm in engineered floorboards. Diagonal fibres, discolouration and core radius are acceptable. Sapwood: acceptable in solid and engineered floorings (up to 50% of the face surface).

**RUSTIC CLASS** (marked in the relevant standards with the symbol  $\square$ ) – diverse wood colour and structure. Knots, filling of knots and fractures, sapwood, discolouration: acceptable regardless of the quantity and size, as long as the flooring strength or wear resistance are not compromised. Low number of insect holes is acceptable, as well as all other defects unacceptable in other classes. Knotholes sealed with filler are acceptable. Filled knots must conform to strength requirements. The filler compound is more resistant to mechanical damage than natural wood knots. Applying appropriate fillers ensures many years of trouble-free use of the flooring.

ATTENTION! The acceptable share of another sorting class in the delivered batch is max. 3%. Fractures and filler compound loss are acceptable. The acceptable length deviation should not exceed  $\pm 2$  mm; the longitudinal buckling should not exceed 0.5% of length, and the transverse buckling should not exceed 0.7% of width at the moment of release from the manufacturing plant (EN 13226). Due to the specific character of large-format floorings (applicable to floorboards longer than 2,500 mm), grooves of up to 1.5 mm may appear on long joints. The grooves can be reduced by using assembly belts to compress the floorboards. The dimensions of floorboards can change depending on moisture content – dimensional differences can reach ca. 0.25% for each 1% of moisture content. Filled knots with filler loss are acceptable. Floorboards damaged on the underside are acceptable, provided that the damage does not significantly affect the colours and properties of the specific selection, and do not affect the strength of the top layer of the floorboard face. Hidden defects in the wood structure (fractures along fibres, knot movement) revealing themselves after several months of use of the flooring are not subject to warranty claims. Such defects are wood property and are impossible to detect in the manufacturing process.

Other, undescribed properties are addressed by the PN-EN 13226 standard for solid floorboards, and the PN-EN 13489 standard for engineered floorboards.

Natur Class – corresponding to Class  $\Delta$  in the standard

Rustic Class – corresponding to Class  $\square$  in the standard

Technical commentary of Solid floors:

Classification - detailed classification available in EN-PN 13226 General provisions EN-PN 13226. All dimensions are based on a reference humidity of 9%. Unless otherwise evidenced, it should be assumed that the thickness and width of a piece of wood increases by 0.25% for every 1% moisture content above the reference moisture content and decreases by 0.25% for every 1% moisture content below the reference moisture content. Moisture must be measured electrometrically according to EN 13183-2. In case of dispute, the moisture must be determined by the drying-weigh method in accordance with EN 13183-1.

Technical commentary of engineered floors:

Classification - detailed classification available in EN-PN 13489 General provisions EN-PN 13489. All requirements given refer to a humidity of 7% and apply at the time of leaving the manufacturer's plant. Methods for measuring geometric features are described in EN 13647. NOTE For simplified calculations, it is recommended to assume that the thickness and width of the element changes by 0.25% per 1% change in humidity.

Moisture – the only appropriate method for measuring the moisture content of multi-layer flooring elements is given in EN 13183-1 (weigh-dryer method).